

Description

The DL0521P1 is a bi-directional TVS diode, utilizing leading monolithic silicon technology to provide fast response time and low ESD clamping voltage, making this device an ideal solution for protecting voltage sensitive high-speed data lines. The DL0521P1 has an ultra-low capacitance with a typical value at 0.3pF, and complies with the IEC 61000-4-2 (ESD) standard with $\pm 25\text{kV}$ air and $\pm 22\text{kV}$ contact discharge. It is assembled into an ultra-small 1.0 x 0.6 x 0.5mm lead-free DFN package. The small size, ultra-low capacitance and high ESD surge protection make DL0521P1 an ideal choice to protect cell phone, digital video interfaces and other high speed ports.

Mechanical Characteristics

- ◆ Package: DFN1006-2 (1.0 x 0.6 x 0.5mm)
- ◆ Case Material: "Green" Molding Compound.
- ◆ Moisture Sensitivity: Level 3 per J-STD-020
- ◆ Terminal Connections: See Diagram Below
- ◆ Marking Information: See Below

Dimensions and Pin Configuration

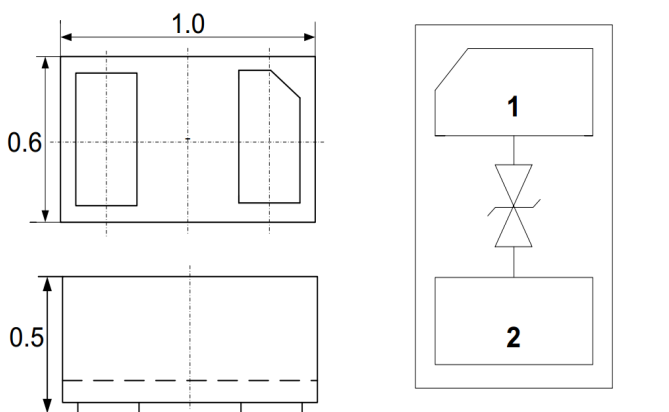

Package Dimensions

Circuit and Pin Schematic

Features

- ◆ Ultra small package: 1.0 x 0.6 x 0.5mm
- ◆ Ultra low capacitance: 0.3pF typical
- ◆ Ultra low leakage: nA level
- ◆ Operating voltage: 5V
- ◆ Low clamping voltage
- ◆ 2-pin leadless package
- ◆ Complies with following standards:
 - IEC 61000-4-2 (ESD) immunity test
Air discharge: $\pm 25\text{kV}$
Contact discharge: $\pm 22\text{kV}$
 - IEC61000-4-5 (Lightning) 5A (8/20 μs)
- ◆ RoHS Compliant

Applications

- ◆ Cellular Handsets and Accessories
- ◆ Display Ports
- ◆ MDDI Ports
- ◆ USB Ports
- ◆ Digital Visual Interface(DVI)
- ◆ PCI Express and Serial SATA Ports

Marking Information



Ordering Information

Part Number	Marking	Packaging	Reel Size
DL0521P1	21	10000/Tape & Reel	7 inch

Absolute Maximum Ratings ($T_A=25^{\circ}\text{C}$ unless otherwise specified)

Parameter	Symbol	Value	Unit
Peak Pulse Power(8/20 μs)	Ppk	100	W
Peak Pulse Current(8/20 μs)	I _{PP}	5	A
ESD per IEC 61000-4-2 (Air)	V _{ESD}	± 25	kV
ESD per IEC 61000-4-2 (Contact)		± 22	
Operating Temperature Range	T _J	-55 to +125	$^{\circ}\text{C}$
Storage Temperature Range	T _{stg}	-55 to +150	$^{\circ}\text{C}$

Electrical Characteristics ($T_A=25^{\circ}\text{C}$ unless otherwise specified)

Parameter	Symbol	Min	Typ	Max	Unit	Test Condition
Reverse Working Voltage	V _{RWM}			5	V	
Breakdown Voltage	V _{BR}	6.5		9.5	V	I _T = 1mA
Reverse Leakage Current	I _R			0.2	μA	V _{RWM} = 5V
Clamping Voltage	V _C			12	V	I _{PP} = 1A (8 x 20 μs pulse)
Clamping Voltage	V _C			25	V	I _{PP} = 5A (8 x 20 μs pulse)
Junction Capacitance	C _J		0.3	0.5	pF	V _R = 0V, f = 1MHz

Typical Performance Characteristics (TA=25°C unless otherwise Specified)

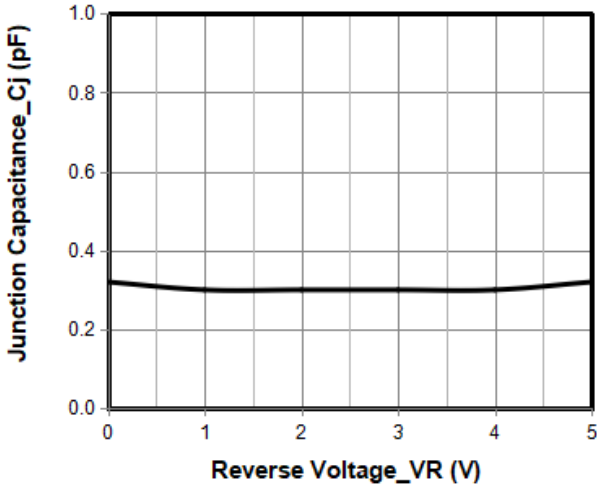

Junction Capacitance vs. Reverse Voltage

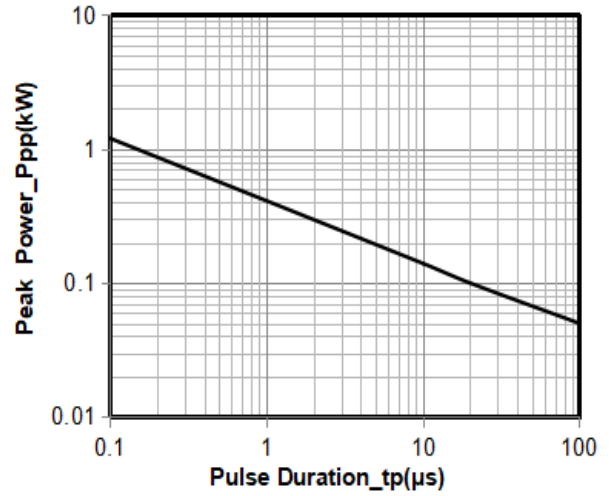

Peak Pulse Power vs. Pulse Time

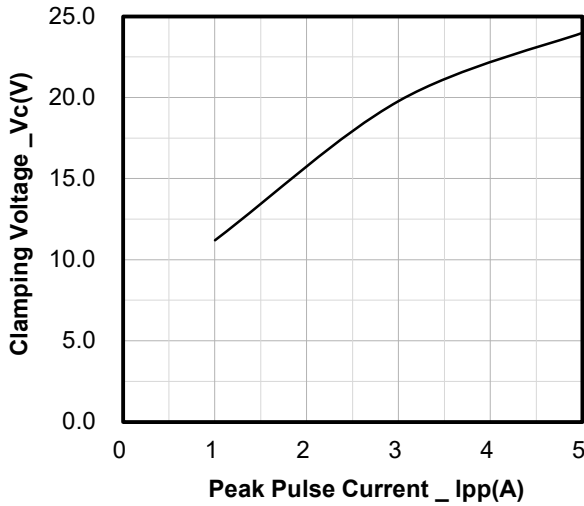

Clamping Voltage vs. Peak Pulse Current

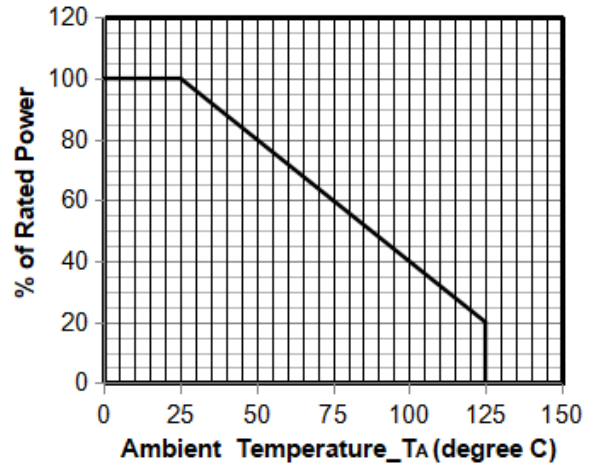

Power Derating Curve

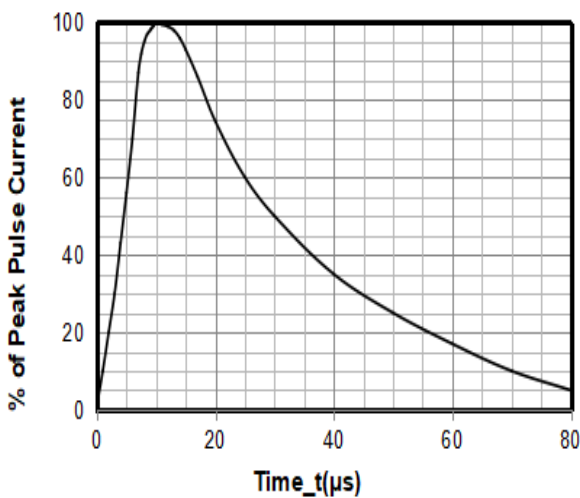

8 X 20 s Pulse Waveform

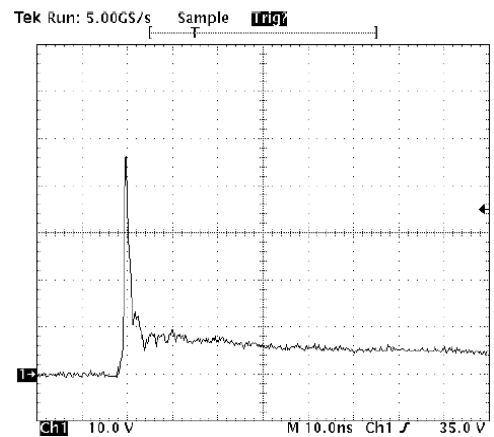

Note: Data is taken with a 10x attenuator

ESD Clamping Voltage

8 kV Contact per IEC61000-4-2

DFN1006-2 Package Outline Drawing

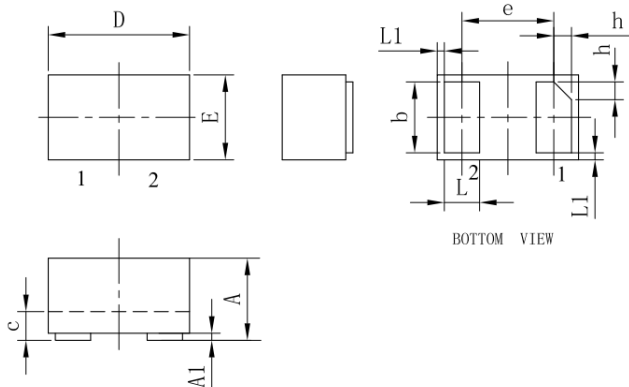

SYM	DIMENSIONS					
	MILLIMETERS			INCHES		
	MIN	NOM	MAX	MIN	NOM	MAX
A	0.450	0.500	0.550	0.018	0.020	0.022
A1	0.000	0.020	0.050	0.000	0.001	0.002
b	0.450	0.50	0.550	0.018	0.020	0.022
c	0.120	0.150	0.180	0.005	0.006	0.007
D	0.950	1.000	1.050	0.037	0.039	0.041
e	0.65 BSC			0.026 BSC		
E	0.55	0.60	0.65	0.022	0.024	0.026
L	0.20	0.25	0.30	0.008	0.010	0.012
L1	0.05REF			0.002REF		
h	0.07	0.12	0.17	0.003	0.005	0.007

Suggested Land Pattern

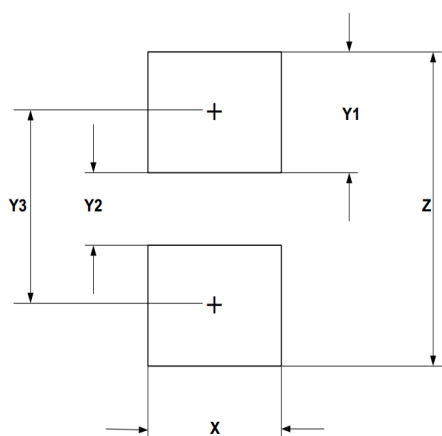

SYM	DIMENSIONS	
	MILLIMETERS	INCHES
X	0.60	0.024
Y1	0.50	0.020
Y2	0.30	0.012
Y3	0.80	0.032
Z	1.30	0.052

Contact Information

Changzhou D-first Electronics CO.,Ltd.

www.first-electronic.com

Email: xhf@first-electronic.cn

Phone: +86 (0519) 8817 1671